

SALUS[®]

C O N T R O L S

Model: EP210

Dual channel programmable controller



Installation Manual

Introduction	3
Product Compliance	4
Safety Information	4
Box content	4
Features	5
Installation	5
Button functions	7
LCD icons	8
Operations	9
Functions	18
Factory Reset	21
Technical Info	22
Warranty	23

The EP210 dual channel programmable controller is a stylish wired timer that can be used for central heating and also for the hot water. Each output will control one zone, meaning that you can create personalized schedules for each channel.

The EP210 programmable controller will switch ON and OFF your central heating system and/or hot water in your home as needed. It works by controlling the heating boiler according to a series of programmed settings that take effect at different times of the day.

By using the EP210 controller you can manage the commands sent to your boiler, motorized valves used in your system or to your thermostat. You can set the EP210 programmable controller to a 12 or 24 hour format, the Daylight saving Time (DST) being automatically enabled. The program mode is also selectable between a 5-2 (Monday-Friday and Saturday-Sunday) or 24 hour format. For each of the programs you can create three settings per day.

Being a complex programmable controller, the EP210 gives you the possibility to override your programs by using the Boost function. This can be enabled for up to 9 hours.

For the periods when you are away you can use the Holiday function, which will turn off the relay. The Holiday Mode can be set for a period of maximum 31 days.

When connected to a system with a non-programmable (digital) thermostat, it can turn the boiler ON or OFF and control the heating and/or hot water in your system in a programmed manner.

The heating system and the hot water will be controlled with the EP210, meaning that this will send the command of turning the relay on or off when needed, according to the programs created.

The EP210 programmable controller does not detect or adjust the temperature in your house, it is just sending the commands to the boiler, motorized valve or the thermostat to turn ON or OFF the relay, depending on the program settings.

The programs can be set individually for each channel, or, you can program them together if you want your heating and hot water to be controlled in a coordinated manner.

Product compliance

This product complies with the essential requirements and other relevant provisions of the following EU Directives: 2014/30/EU, 2014/35/EU and 2011/65/EU. Please check www.saluslegal.com for the full information.

Safety Information

Use in accordance with the EU and national regulations. For indoor use only. Keep your device completely dry. This product must be installed by a competent person and in accordance with all the EU and national regulations.



Always isolate the AC Mains supply before installing or working on any components that require 230 VAC 50Hz supply.

Box content

The box includes the EP210 controller, 2X screws and plugs and the Quick Guide installation manual.



EP210 Controller



2x screws and plugs



Quick Guide Installation

Features

- Dual Channel Programmer for Central Heater or Hot Water
- 12 or 24 hour clock format
- 5+2 or 24 h individual programs with 3 settings per day
- Boost function
- Holiday function
- Advance function
- Memory backup



Installation

Wiring and terminal description

Terminal	Description	Backplate
N	Mains Neutral	
L	Mains Live	
1	Hot Water Off	
2	Central Heating Off	
3	Hot Water On	
4	Central Heating On	
	Earth Parking (no electrical connection)	

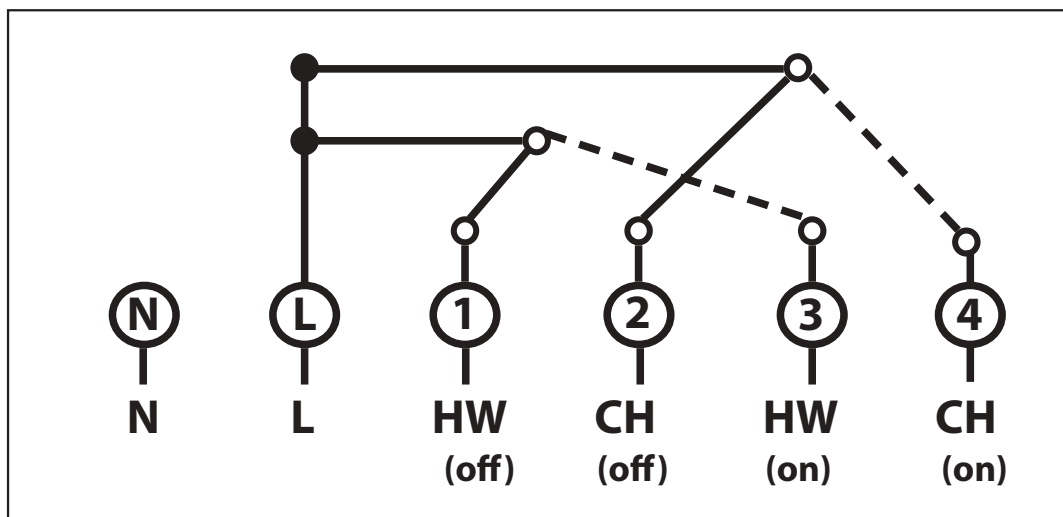

Wall mounting



Fix the backplate to the wall.



Align the front housing at the top edge.



Fit the front housing. Press lightly.

Jumper settings

The jumpers are found on the rear of your controller and can be used to change the settings for the: program type, system type (fully pumped and controlled or gravity-fed) and internal backup memory battery. If you want to change the position of the jumpers, please note that you will need to reset your device.

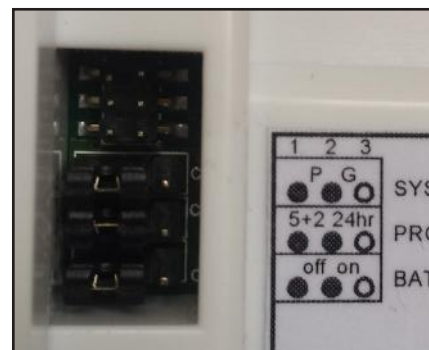





EP210 Switching Bridges				
Switch	Feature	Setting		Default
System	Fully pumped system(P*)or gravity-fed hot water system(G*)	P <input checked="" type="radio"/> <input type="radio"/> <input type="radio"/>	G <input type="radio"/> <input checked="" type="radio"/> <input checked="" type="radio"/>	Fully pumped and controlled system
Program	5-2 days program or 24h program	5-2 <input checked="" type="radio"/> <input type="radio"/> <input type="radio"/>	24H <input type="radio"/> <input checked="" type="radio"/> <input checked="" type="radio"/>	5-2 days program
Memory Backup	Disable/enable the internal backup battery	OFF <input checked="" type="radio"/> <input type="radio"/> <input type="radio"/>	ON <input type="radio"/> <input checked="" type="radio"/> <input checked="" type="radio"/>	Internal backup battery disabled

Note: Changes to the jumper setting should only be made by the engineer carrying out the installation or another qualified person. The installer should select the jumper positions required if changes need to be made to the factory default settings. These jumpers are found on the rear of the controller.

Button functions



Key	Function
 Mode	Press to select ON/ONCE/AUTO/ADV/OFF for hot water
 Mode	Press to select ON/ONCE/AUTO/ADV/OFF for heating
+Hr	Press to enter/cancel Boost override function by setting Boost hours.
Select	Press to select the setting of clock/date/week day, etc.
Set	Press to confirm the setting.
Up arrow	Press to increase clock/day, press and hold to enter fast advance.
Down arrow	Press to decrease clock/day, press and hold to enter fast advance.
	Press to activate backlight.
	Hardware reset
	Press and hold button for 3 seconds to activate Holiday mode.
Select + Set	Press and hold buttons to enter clock setting mode.

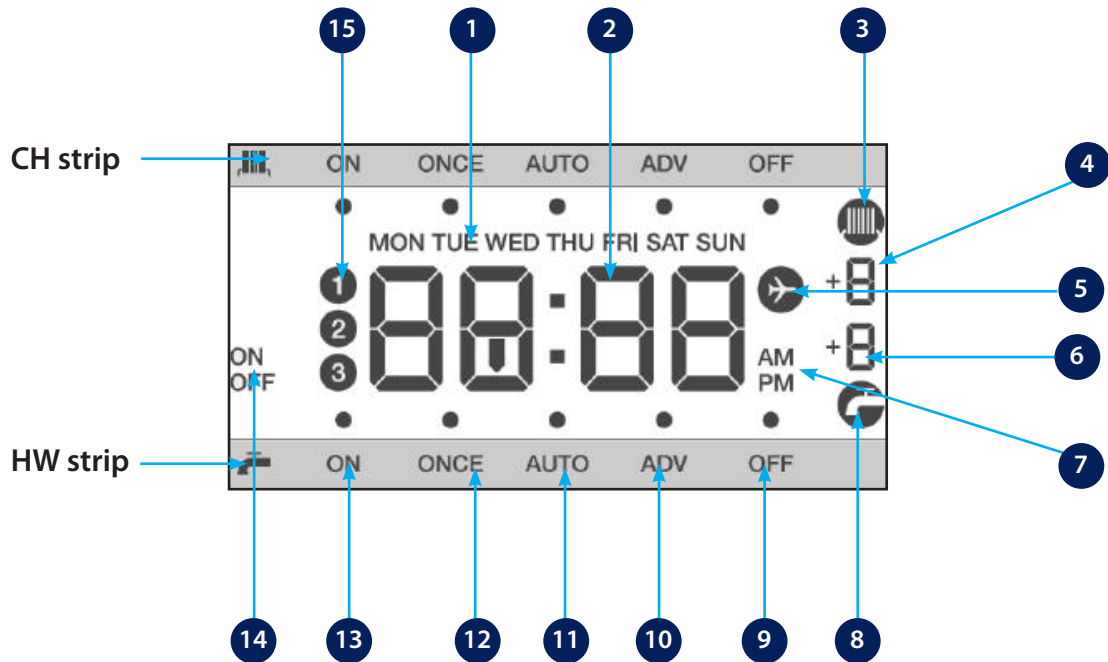

- 1 Days of the week
- 2 Clock
- 3 Heating zone
- 4 Boost hours for heating
- 5 Holiday Mode
- 6 Boost hours for hot water
- 7 AM/PM
- 8 Hot Water On
- 9 OFF Mode
- 10 ADV Mode On
- 11 AUTO Mode On
- 12 ONCE Mode On
- 13 On Mode
- 14 DST On/Off
- 15 Program number

Initial power up

After power up or after RESET is pressed, the programmer is reset to factory default settings. During system reset, all LCD icons and segments are turned on for 2 seconds and all keys are blocked. After 2 seconds and all keys are released, the programmer is initialized. First the software version is shown and after that the typical reset display is shown. The time should be 12:00am.

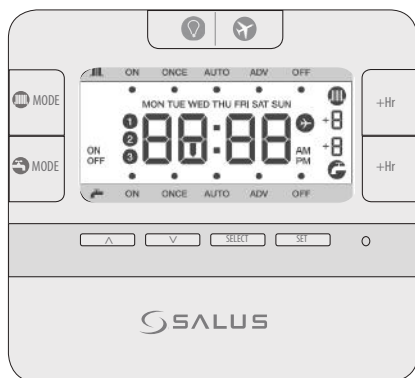

Default settings

Function	Status after Reset
Operation Mode	Normal mode
Clock	12:00 AM
AM/PM indicator	AM
Date	January 1, 2016
Daylight Saving Time(DST)	On
Program	Factory default 5+2
Program Number indicator	Off
SET indicator	Off
PROG indicator	Off
Mode indicator(s)	"Off"
Output Relay	Off
CH/HW indicator(s)	Off

Setting time and date

The first thing you will have to do is to set the time and date on your controller. First you will need to set up the time and then the date. To enter clock setting mode, press and hold **Select** and **Set** buttons for 3 seconds. Please follow the instructions below.



Press and hold the indicated buttons together for 3 sec.

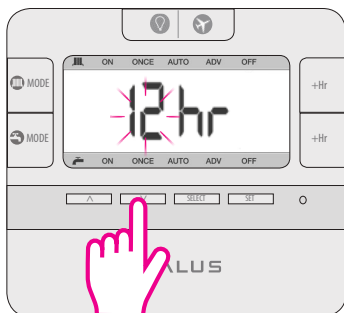

Choose your clock format
Press Up/Down arrow for
12/24 hr format.



Press Select to confirm.

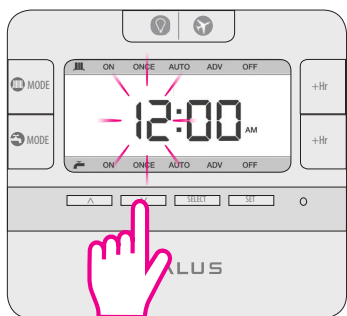

Press Up or Down to
set the hour.



Press Select to confirm.

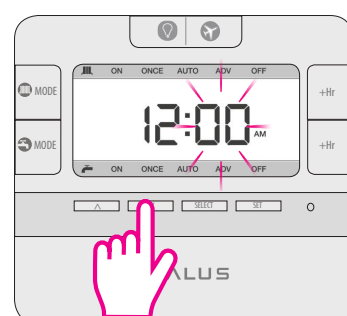

Press Up or Down to
set the minutes.

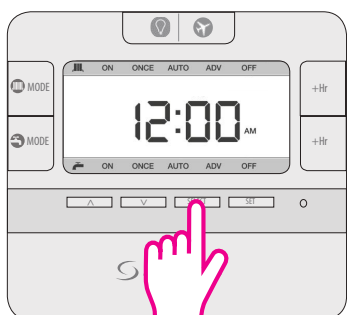

Press Select to confirm.

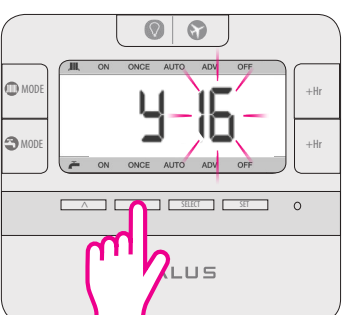

Press Up or Down to
set the year.

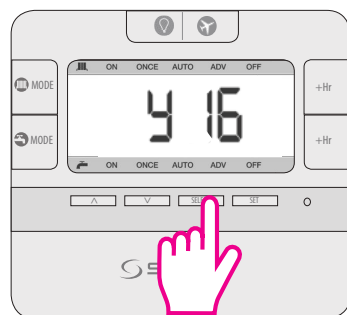

Press Select to confirm.

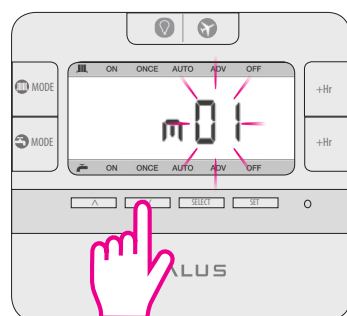

Press Up or Down
to set the month.

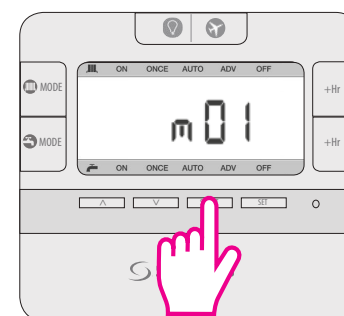

Press Select to confirm.

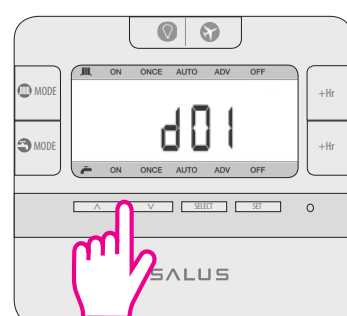

Press Up or Down
to set the date.

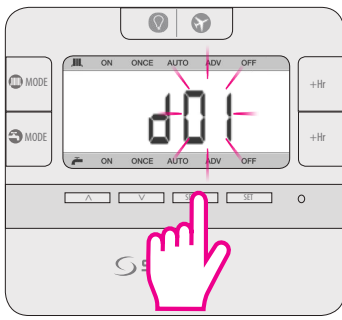

Press Select to confirm.

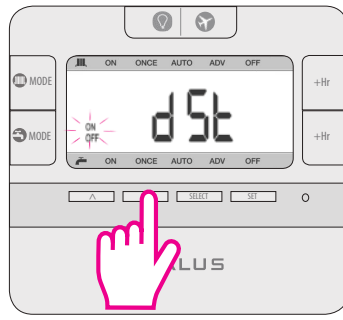

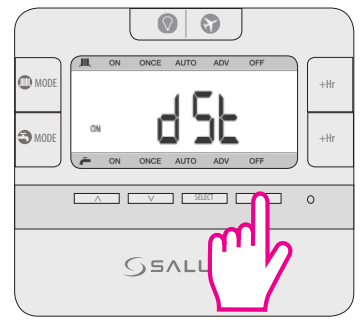

Press Up or Down to select DST on/off.



Press Set to confirm and exit to normal mode.

When Daylight saving time is enabled, the clock will automatically change from Greenwich Mean Time (GMT) to British Summer Time (BST) on the last Sunday in March. The clock will automatically change back to GMT on the last Sunday in October.

Operating Modes

EP210 can operate in 5 different modes, applicable to the CH, HW or CH+HW. The operation modes are the same for CH and HW and can be set individually, or together. If you want to choose the mode for the CH, press the  **Mode** key. If you want to choose the mode for the HW, press the  **Mode** Key.

Operation Mode	Function
ON	Continuously on
ONCE	On for 1 period a day, from Program 1 ON to Program 3 OFF
AUTO	Automatic program control
ADV	When device is in Auto or Once mode, press the MODE button for 3 sec for selecting Advance (ADV). This will move the unit into the next program. When the ADV function ends the device will return to normal program.
OFF	Continuously off

For activating the functions described above, press the **MODE** button. The operating mode is cycled in the below sequence:

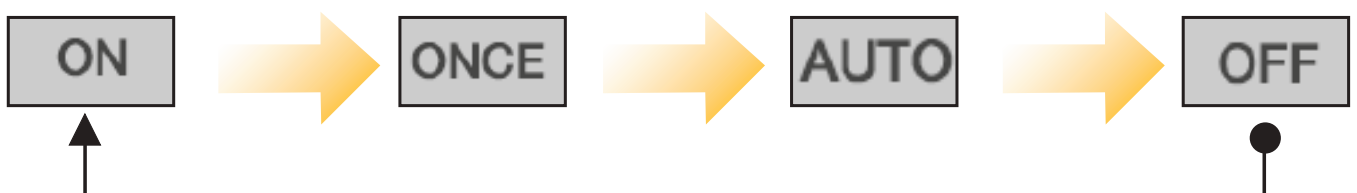

ON Mode

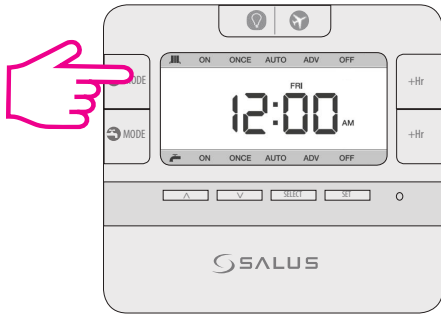

Press for CH mode.

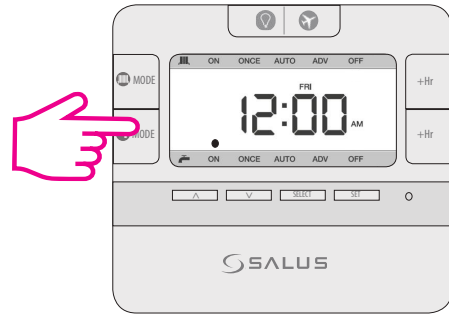

Press for HW mode.

Pressing the Mode key once activates the ON Mode. In ON mode, the controller gives the boiler the ON command, so the heating or/and hot water will run continuously.

ONCE Mode

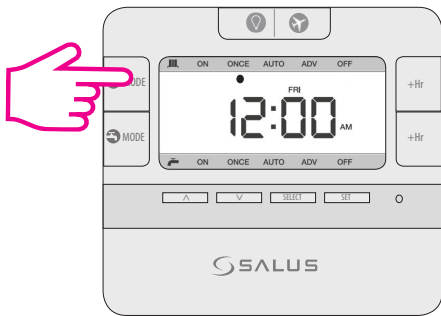

Press for CH mode.

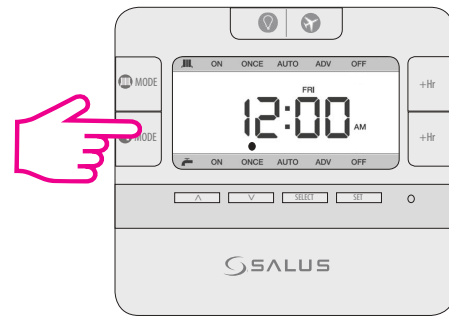

Press for HW mode.

Pressing the Mode key twice activate the ONCE Mode. In ONCE mode, the controller gives the boiler the command to run only for one period per day (from program 1 ON to program 3 OFF)

Auto Mode

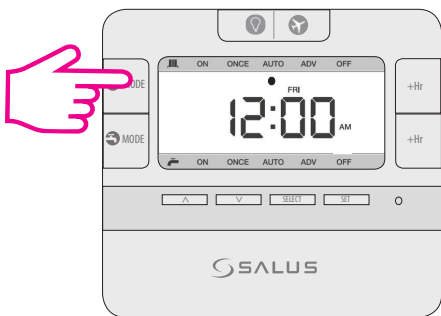

Press for CH mode.

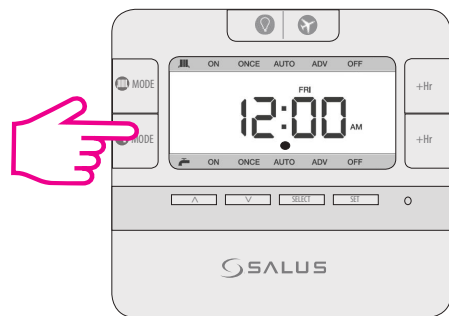

Press for HW mode.

Pressing the Mode key 3 times activates the AUTO. In AUTO mode, the controller gives the boiler the ON/OFF command depending on your schedule.

OFF Mode

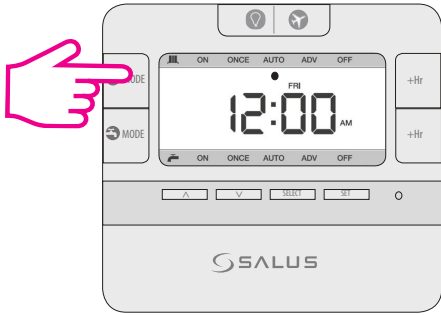

Press for CH mode.

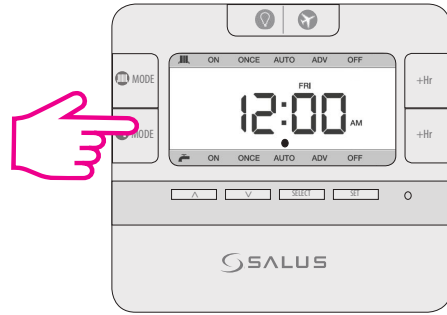

Press for HW mode.

Pressing the Mode key 4 times activates the OFF Mode. In OFF mode, the controller gives the boiler the OFF command, so the heating or the hot water will be turned off.

ADV Mode

Note: In ONCE or AUTO mode, by long pressing the MODE button, the controller will switch automatically to ADV. You can cancel the ADV by long pressing the MODE key. The device will then return to ONCE or AUTO mode. You can't select ADV by pressing Mode key

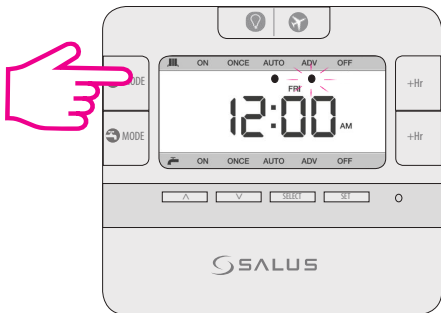

Press for CH mode.

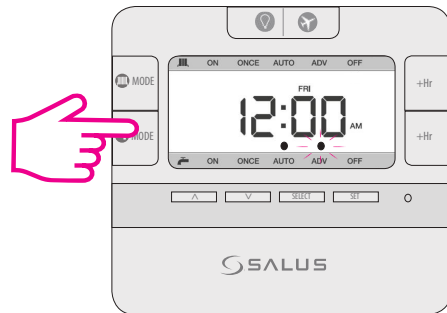

Press for HW mode..g

When in Auto mode selecting ADV, the controller will simply toggle the current auto setting (ON or OFF). For example, if the current program is set as:

08:00 ON → 09:00 OFF → 10:00 ON → 11:00 OFF

Selecting ADV between 8:00 and 8:59 will change the output to OFF, from 9:00 onwards back to AUTO (which is also OFF). Selecting ADV between 9:00 and 09:59 will change the output to ON, from 10:00 onwards back to AUTO (which is also ON). If the ADV puts the relay ON then the boost would apply immediately at the next OFF change, if the ADV put the relay OFF then the boost would apply immediately and turn the relay ON.

08:00 OFF → 10:00 ON → 12:00 OFF → 14:00 ON

If ADV occurs at 08:30 and the relay is ON from 08:30 to 12:00. During this period, if at 08:45 +1Hr (Boost) is pressed, the relay will be ON from 08:30 to 12:00. Boost is applied immediately ie. from 08:45 to 09:45 at the next change, ie. 12:00. If ADV occurred at 10:30 the relay will be ON from 10:00, OFF from 10:30 (ADV) to 14:00 if no +1Hr Override. During ADV, if at 10:45 +1Hr (Boost) is pressed, the relay will go ON again at 10:45 (boost starts), OFF at 11:45 (Boost ends) until ends at 14:00, then ON again at 14:00.



Programming the EP210

2 types of programs can be set:

- 5+2 (Mon to Fri same and Sat, Sun same)
- Different programs for each 24h.

There are 3 different time sets for each day.

5-2 Days Program	Individual Days Program
Weekdays 3 sets of time/channel Weekends 3 sets of time/channel Total: 12 settings/week	1 Day 3 sets of time/channel Total: 42 settings/week

EP210 is a dual channel controller, that gives the possibility to control both Central Heating and Hot Water. You can choose which one you would like to control, by simply pressing the  Mode key for Central Heating, or  Mode key for hot Water, or you can use both. You can program the schedules for these outputs individually or together. When you program them together, there will be the same program time for both Heating and Hot Water. If you choose to program them individually, you can have different program times for each.

5+2 Program

Programing CH and HW individually



Press Set to enter setting programs

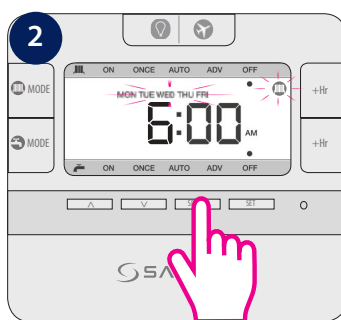

The CH icon and Mon-Fri will start flashing. Tap Select.

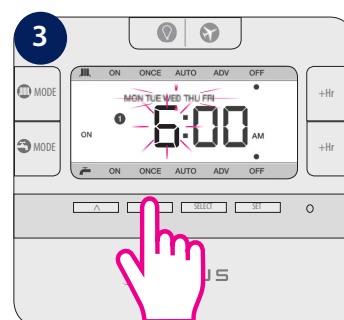

The CH icon will go steady, the program number will appear and you will need to select a start time for the CH program. Use up/down arrows.

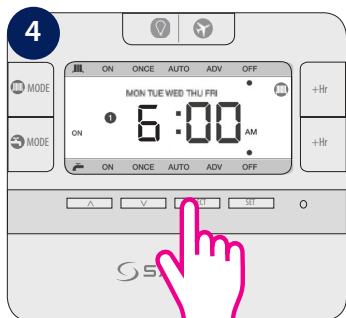

Press Select.

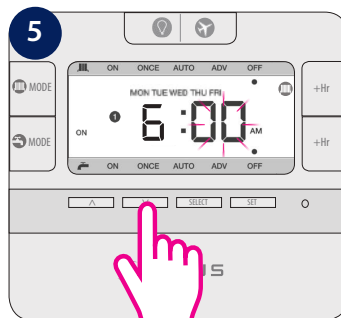

Use up/down arrows to select minutes.



Press Select.

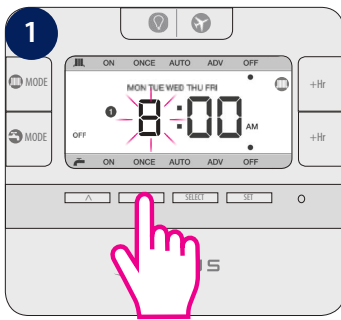

1 Select an end time for the first program.

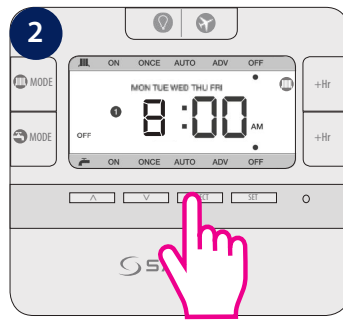

2 Press Select.

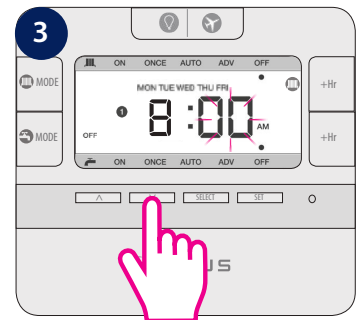

3 Use up/down arrows to select minutes.

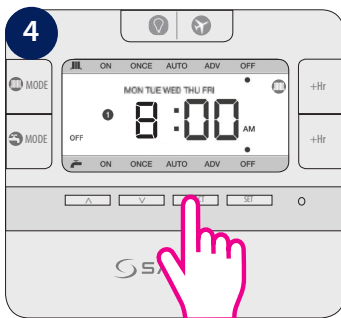

4 Press Select.

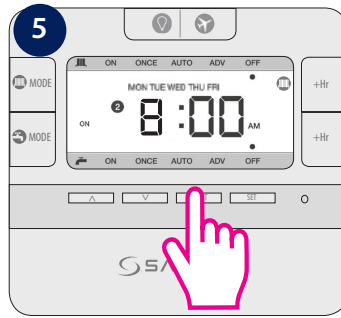

5 Controller will now go to program nr 2.

Please continue by following the same steps for program nr 2 and 3. After you finish programming CH for weekdays, the controller will ask you to do the same thing for the Hot Water. You can choose different or similar end/start time. The LCD will look like step 12.

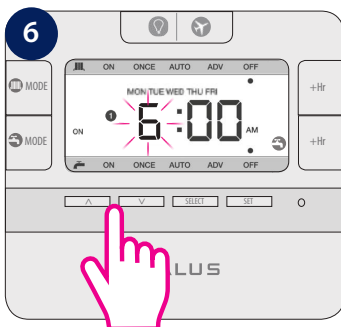

The sequences followed by the controller when programming CH and HW individually goes at it follows:

Weekday CH (program 1-3) → Weekday HW (program 1-3) →

Weekend CH (program 1-3) → Weekend HW (program 1-3) and all over again.

Note: To save your settings and exist to home screen in normal mode, press **Set** at any time.

Programming CH and HW together

The programming principle is exactly the same, but you can only set the **same** Start/End time for the CH and HW. The programming sequence goes as it follows: Weekday CH+HW → Weekend CH+HW and all over again. To program them together, follow the steps:



1 Press Set to enter setting programs .

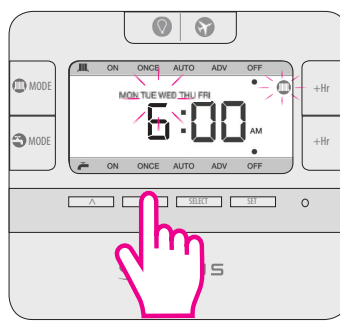

2 The CH icon and Mon-Fri will start flashing. Press up arrow 2 times.

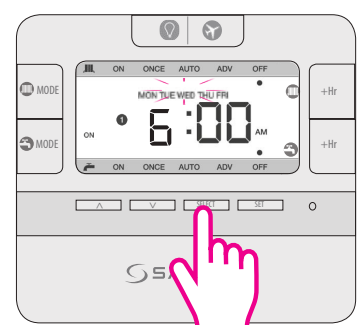

3 Press Select to start entering a start time for the program and then follow the same steps as above from 3-11.

Setting different programs for each 24h

Note: Don't forget to move the jumpers to 24h in order to have the individual program active. After that please follow the same instructions as for the 5-2 days program.

Programming CH and HW individually



Press Set to enter setting programs



The CH icon and Mon will start flashing. Tap Select.

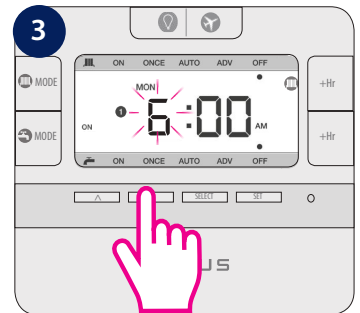

The CH icon will go steady, the program number will appear and you will need to select a start time for the CH program. Use up/down arrows.

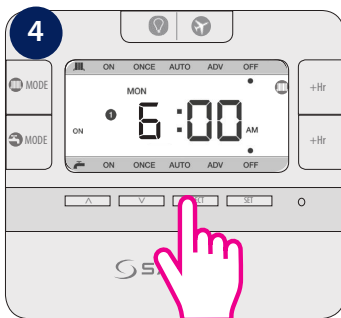

Press Select.

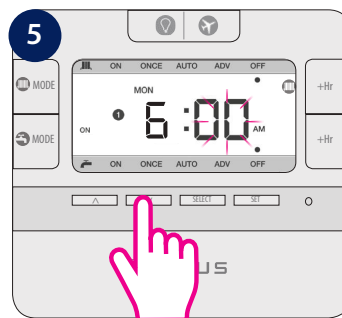

Use up/down arrows to select minutes.

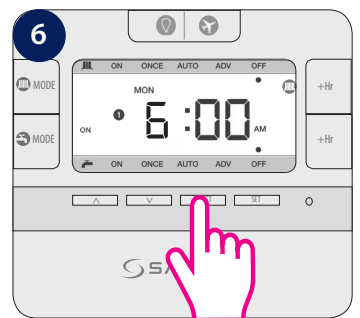

Press Select.

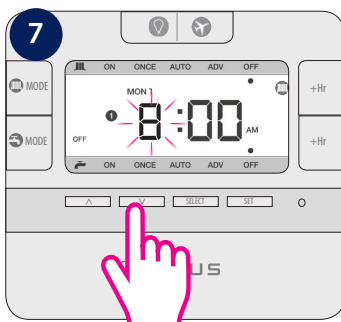

Select an end time for the first program.

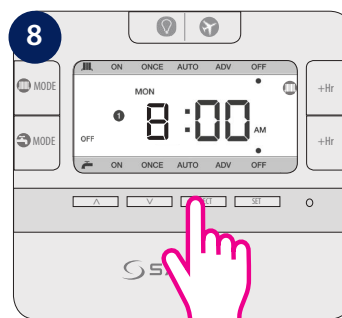

Press Select.

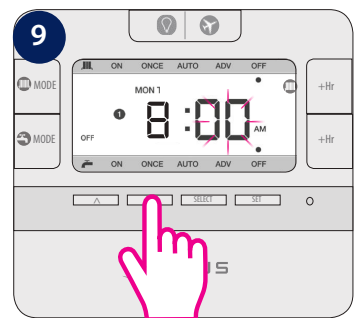

Use up/down arrows to select minutes.

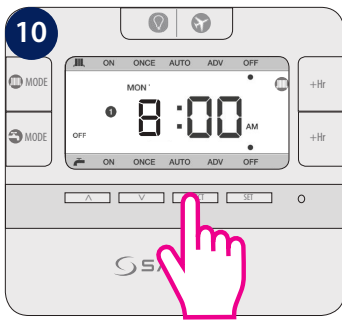

Press Select.

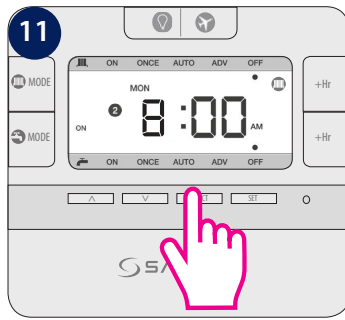

Controller will now go to program nr 2

Please continue by following the same steps for program nr 2 and 3. After you finish programming CH for Monday, the controller will ask you to do the same thing for the Hot Water. You can choose different or similar end/start time. The LCD will look like step 12.

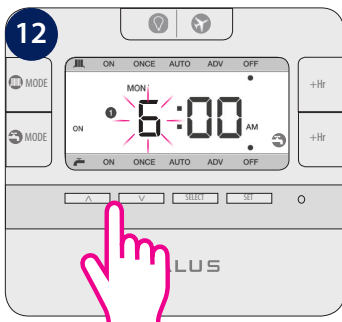

The sequences followed by the controller when programming CH and HW individually goes at it follows:

Monday CH (program 1-3) → Monday HW (program 1-3) →

Tuesday CH (program 1-3) → Tuesday HW (program 1-3) →

Wednesday CH (program 1-3) → Wednesday HW (program 1-3) etc

Note: To save your settings and exist to home screen in normal mode, press **Set** at any time.

Programming CH and HW together

The programming principle is exactly the same, but you can only set the same Start/End time for the CH and HW. The programming sequence goes as it follows: Monday CH+HW → Tuesday CH+HW → Wednesday CH+HW etc.

To program them together, follow the steps:

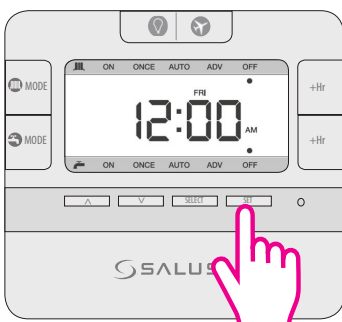

Press Set to enter setting programs .

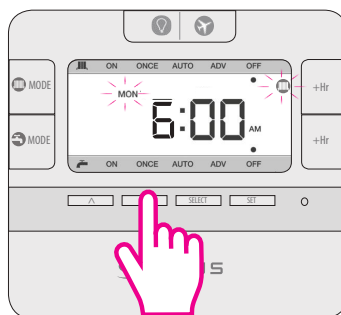

The CH icon and Mon will start flashing. Press up arrow 2 times.



Press Select to start entering a start time for the program and then follow the same steps as above from 3-11.

Temporary Override

Boost Override (+1Hr override)

Boost Override (+1Hr override) is available in ONCE/AUTO/OFF modes. Boost mode can be activated even in ADV mode. When boost mode is activated, ADV is canceled. Press **+1Hr** at current mode to activate the Boost Override (+1Hr override) setting mode. Boost mode increases the time of the active program by 1-9 hours. The new setting hour "+x" (x=last boost hour+1 hour) is displayed. Subsequent press of **+1Hr** will increase the duration by 1 hour. Maximum duration is 9 hours. If the number rolls back to blank, this will disable the Boost Override.

Boost Override (+1Hr override) for Heating



Press +1Hr to enter Boost override.

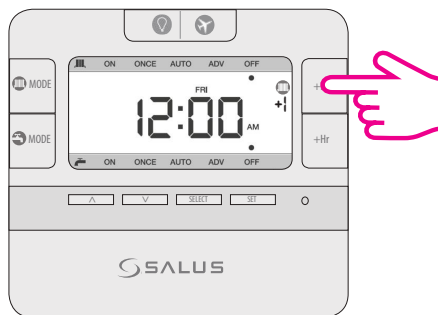

The number of boost hours will be displayed.



To exit boost override, press mode button until number +x disappears.

Boost Override (+1Hr override) for Hot Water

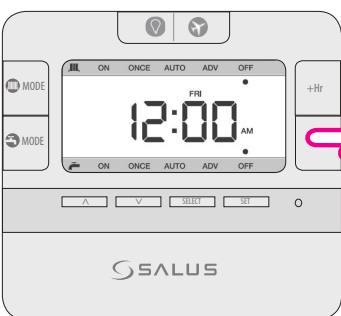

Press +1Hr to enter Boost override.



The number of boost hours will be displayed.



To exit boost override, press mode button until number +x disappears.

Boost Override (+1Hr override) can be available for CH and HW at the same time.

ADV Override

ADV only works in AUTO or ONCE mode. During ADV, press **MODE** once to cancel ADV and go back to AUTO /ONCE mode after LCD backlight is turned off.

+1Hr override and ADV cannot co-exist in same channel. During ADV mode, when **+1Hr** is pressed, override mode will cancel ADV mode then change to Boost mode. If +1Hr override (Boost) is running, then ADV is selected, ADV will be activated and the previous +1Hr override will be canceled.

ADV Override for Heating

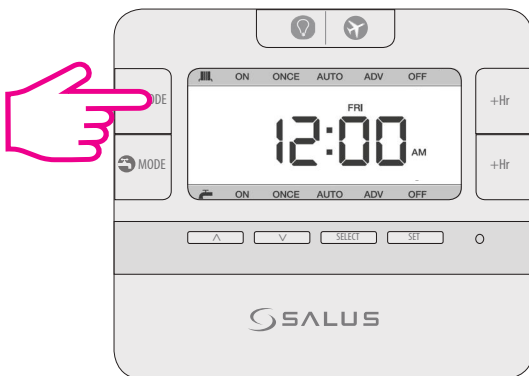

Long press Mode while in Auto or Once to enter ADV override Mode.

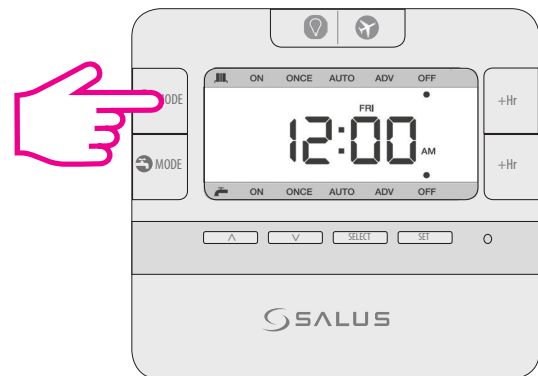

Short press Mode while in ADV to exit mode back to auto or Once.

ADV Override for Hot Water

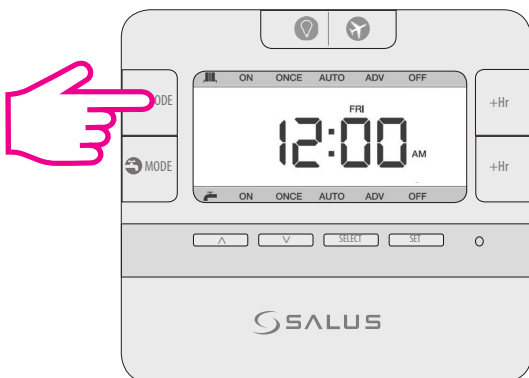

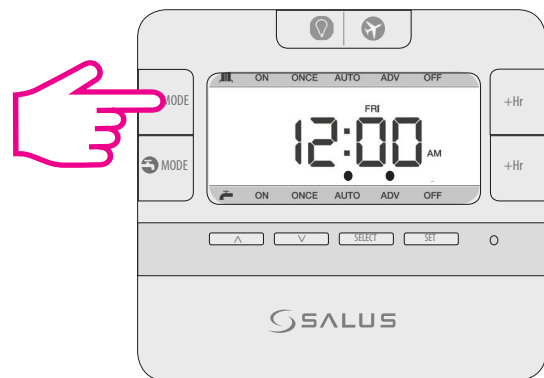

Long press Mode while in Auto or Once to enter ADV override Mode.



Short press Mode while in ADV to exit mode back to auto or Once.

Holiday Override

During the period of holiday override, relay should be always Off.

Press and hold  at current mode for 3 seconds to activate the Holiday Override setting mode. The plane icon will be displayed on the LCD and the user's only option will be to set the number of holiday days (up to 31). To exit Holiday Override and turn On the relay, long press the  key.

Enter Holiday Mode

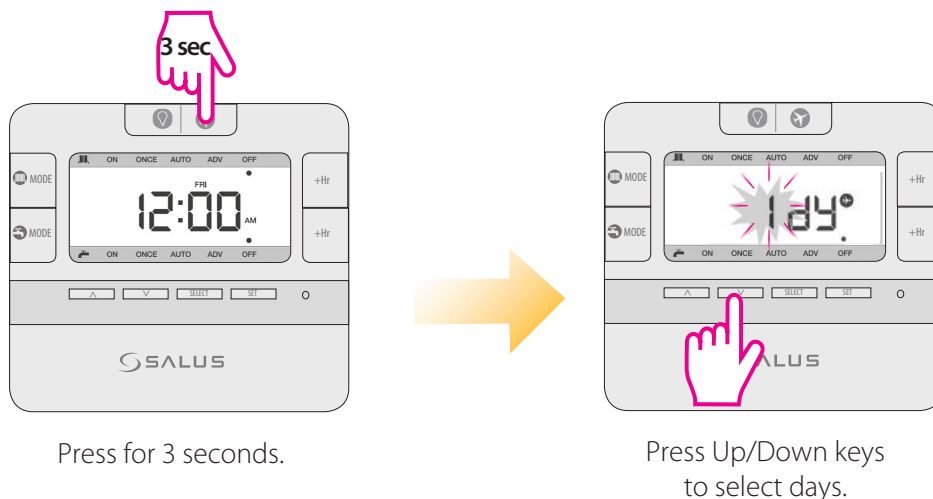

Exit Holiday Mode

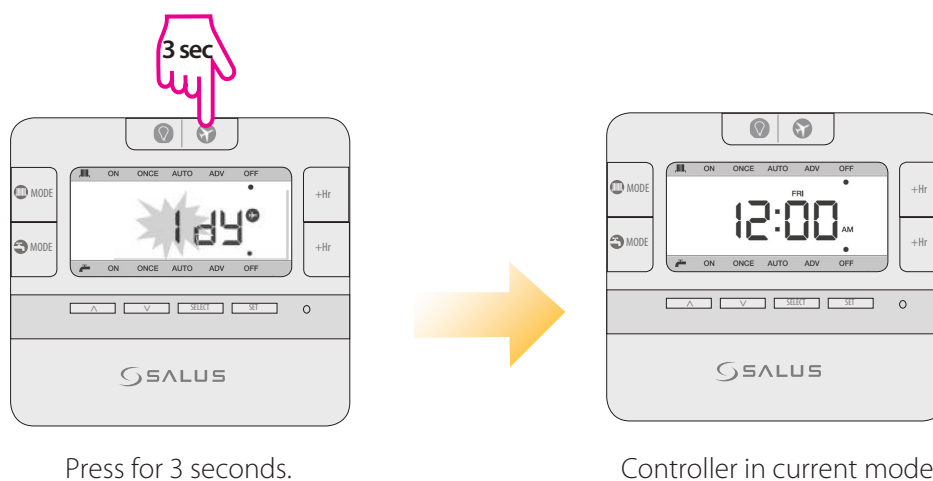

LCD Backlight

If AC is powered, LCD backlight is activated when  or any key is pressed. The backlight will be turned off in 15 seconds after all keys are released.

Factory Reset

If you want to return to the factory settings please press the Reset button once (use a pin for this action).



Press reset button.

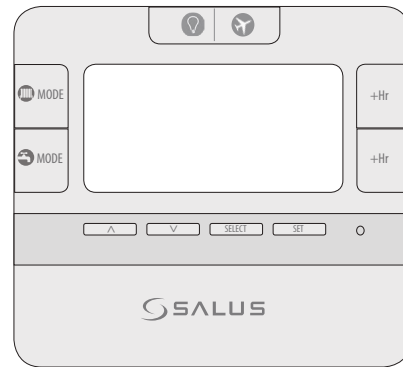

LCD will turn OFF.

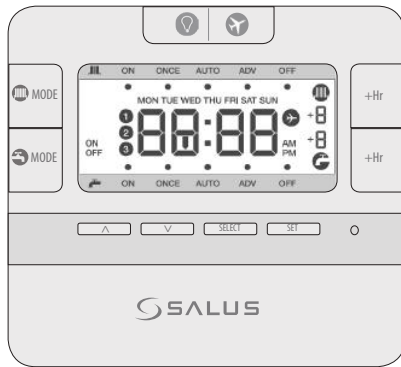

All icons will be displayed.



Software version.



Normal Mode.

Product Specification	
Model:	EP210
Type:	Surface Mounted Wired Dual Channel Programmable Timer
Memory Backup	Lithium battery (CR2032 x1 pc)
Power control	
Rating	230V/50Hz/3(1)A
Relay	SPDT
Protection Rating:	IP 30
Environment	
Operating Temperature/ Humidity:	0°C ~ 50°C, 10% – 90% non-condensing
Storage Temperature/ Humidity	-20°C~- 60°C, 10% – 90% non-condensing
Programs	
Program	5-2 or 24hr individual program (selectable by jumper), 3 settings/day, with holiday override.
Boost Override	Yes, max 9 hours(selectable by software)
Holiday Override	Yes, max 31 days (selectable by software)
Clock	
Clock Format	12 or 24 hour (selectable by software)
Clock Accuracy	+/-1 min/month
Daylight Saving Time (DST)	Yes, Clock automatically adjusted if DST is enabled.

Warranty

SALUS Controls warrants that this product will be free from any defect in materials or workmanship, and shall perform in accordance with its specification, for a period of two years from the date of installation. SALUS Controls sole liability for breach of this warranty will be (at its option) to repair or replace the defective product.

Customer Name:

Customer Address:

..... Post Code:

Tel No: Email:

Company Name:

Tel No: Email:

Installation Date:

Installer Name:

Installer Signature:

SALUS Controls PLC

SALUS House

Dodworth Business Park South,
Whinby Road, Dodworth,
Barnsley S75 3SP, UK.

Sales: T: +44 (0) 1226 323961
E: sales@salus-tech.com

Technical: T: +44 (0) 1226 323961
E: tech@salus-tech.com

www.salus-controls.com



SALUS Controls is a member of the Computime Group

Maintaining a policy of continuous product development, SALUS Controls plc reserves the right to change specification, design and materials of products listed in this brochure without prior notice.

For the latest PFD Instruction Manual, go to www.salus-manuals.com